

ペーパークラフト NO. 2

沖縄で一番灯塔が高い灯台

残波岬灯台 S.1/100

灯台の大きさ

高さ : 建物 30.6 m 光り 水面から 39.9 m
 塔の太さ : 円筒 下部直径 4.2 m 上部直径 3.8 m
 光のとどく距離 : 17.5 海里 (約 32 Km)
 光りかた : 1.4 秒に 1 回その後 6 秒に 1 回の白光が光る

山折り線

谷折り線

のりしろ

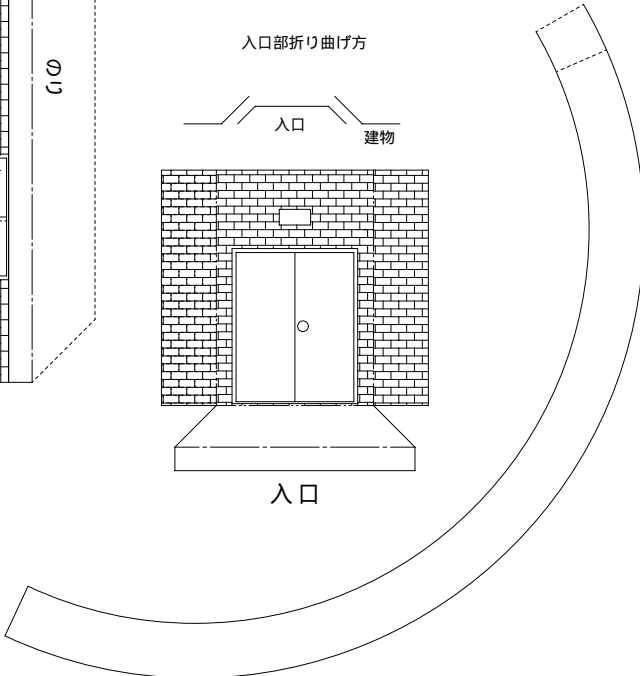
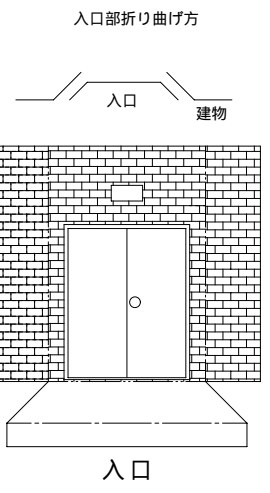
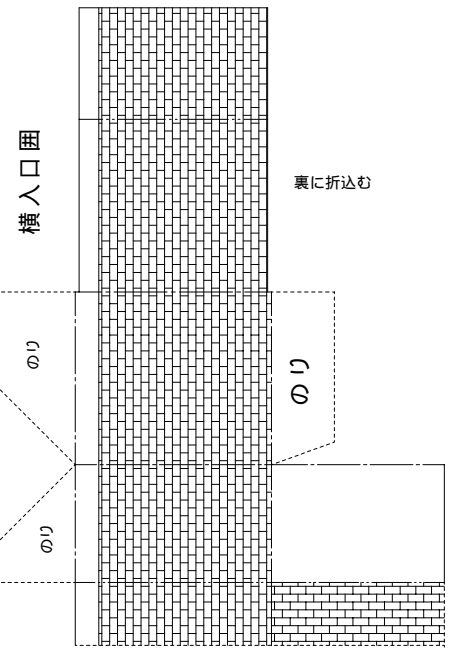
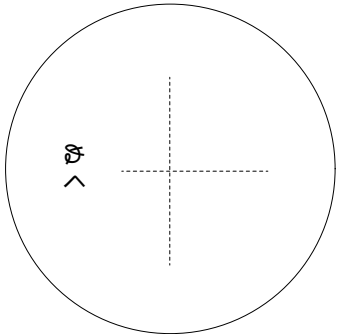
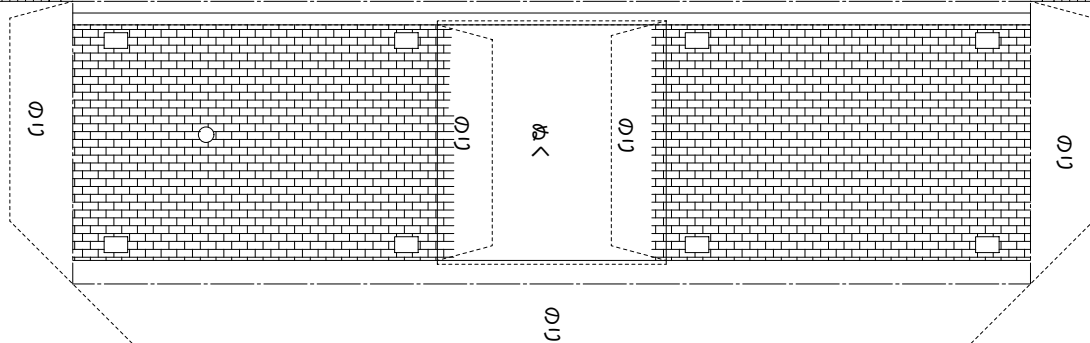
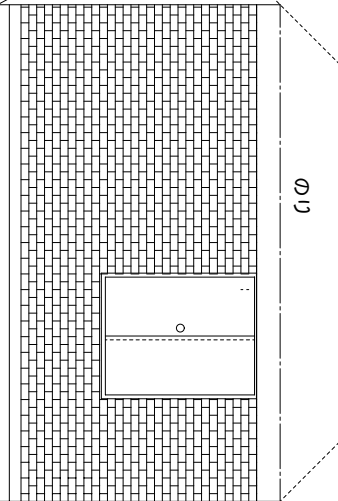
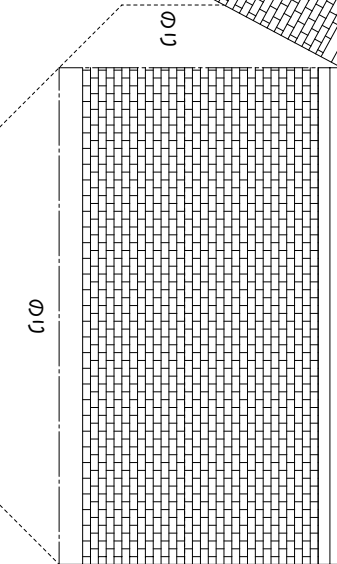
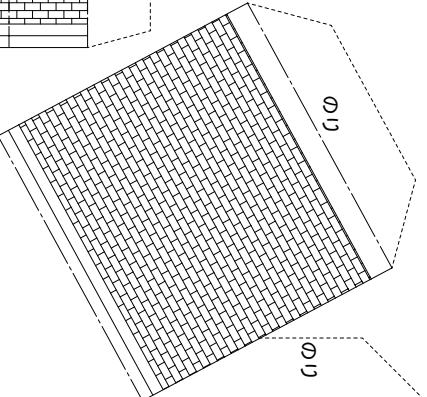
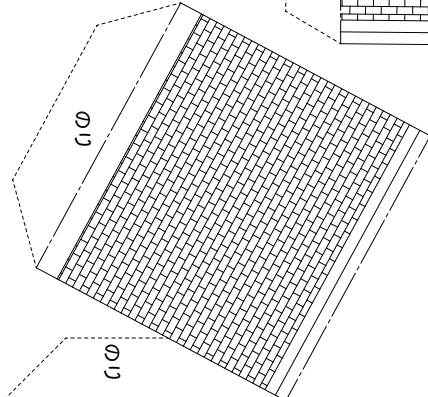
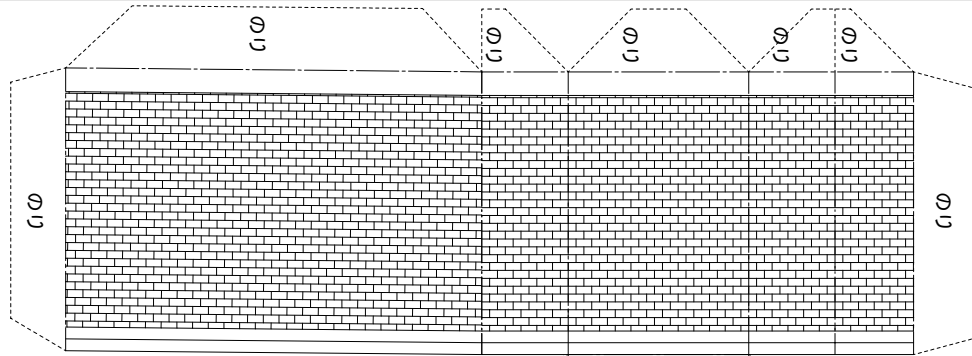

建物

ぬ

ぬ

入口

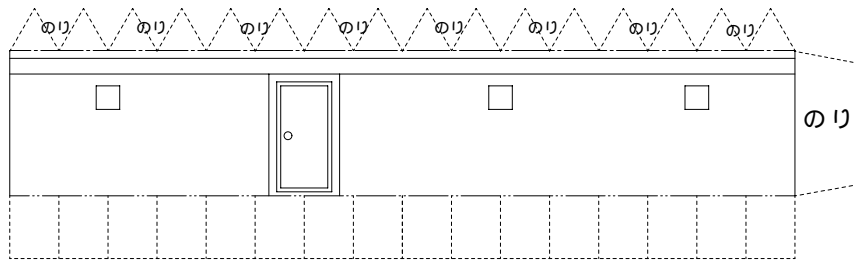

胴壁

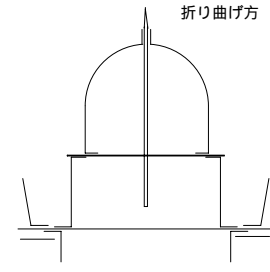

ようじを一本準備してね!

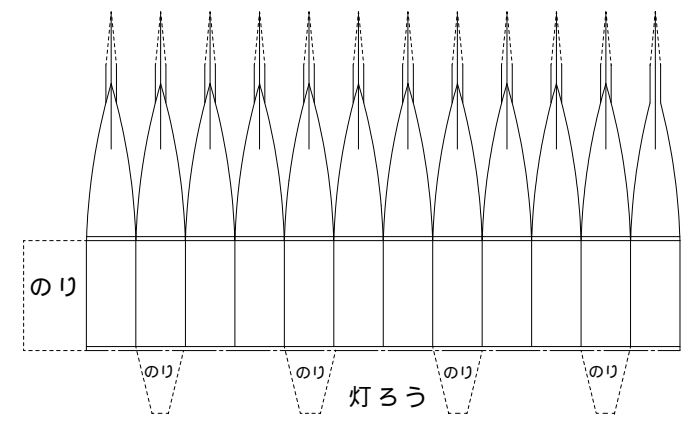

うらにのり

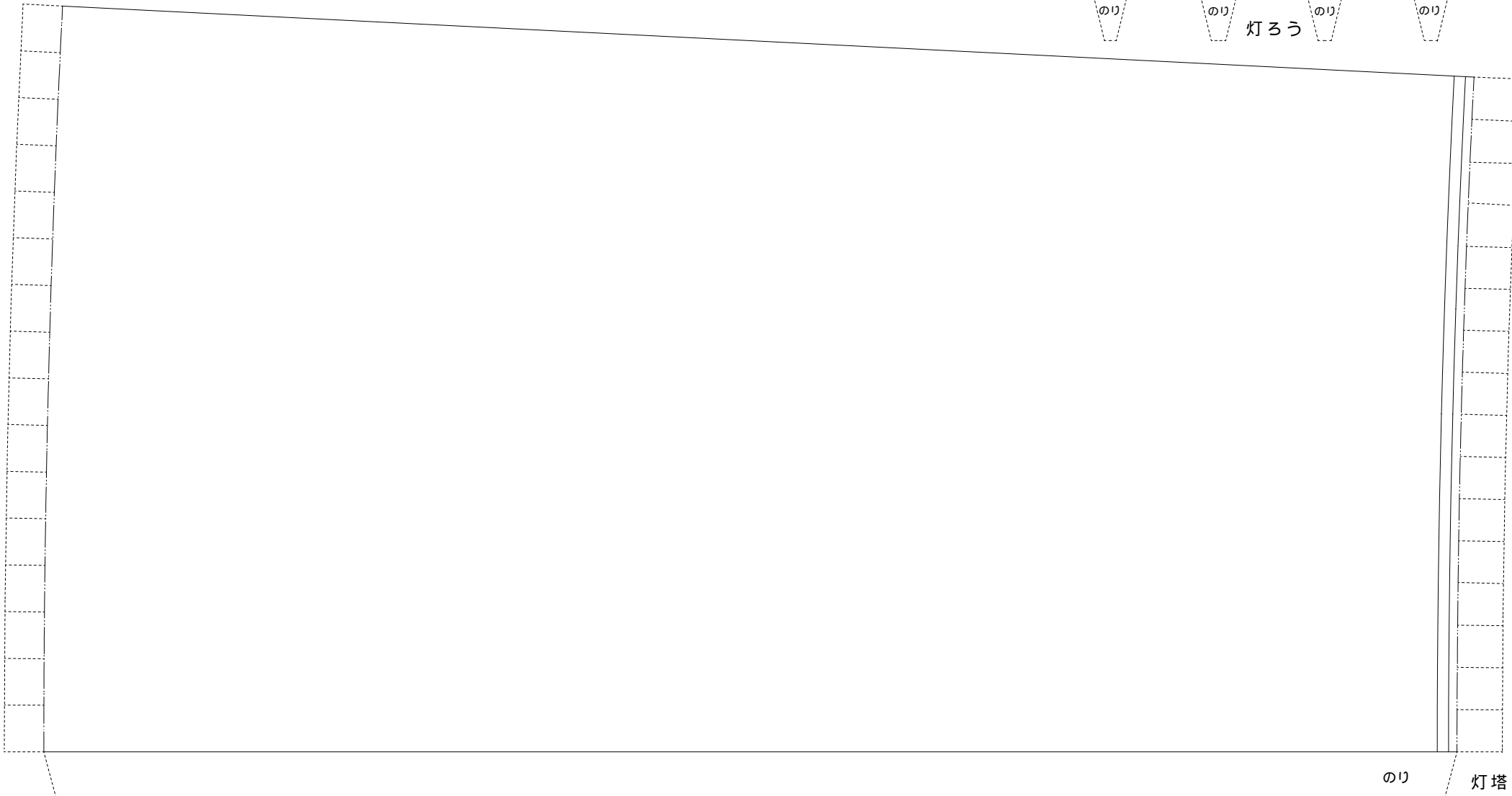

のり

灯塔

灯塔を先に台紙につけ、建物、屋根を組み立て、灯台の上部を組み立てる